

IRFIZ48NPbF

HEXFET® Power MOSFET

- Advanced Process Technology
- Isolated Package
- High Voltage Isolation = 2.5KVRMS ⑤
- Sink to Lead Creepage Dist. = 4.8mm
- Fully Avalanche Rated
- Lead-Free

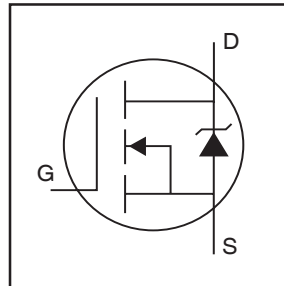

$V_{DSS} = 55V$
$R_{DS(on)} = 0.016\Omega$
$I_D = 40A$

Description

Fifth Generation HEXFETs from International Rectifier utilize advanced processing techniques to achieve extremely low on-resistance per silicon area. This benefit, combined with the fast switching speed and ruggedized device design that HEXFET Power MOSFETs are well known for, provides the designer with an extremely efficient and reliable device for use in a wide variety of applications.

The TO-220 Fullpak eliminates the need for additional insulating hardware in commercial-industrial applications. The moulding compound used provides a high isolation capability and a low thermal resistance between the tab and external heatsink. This isolation is equivalent to using a 100 micron mica barrier with standard TO-220 product. The Fullpak is mounted to a heatsink using a single clip or by a single screw fixing.

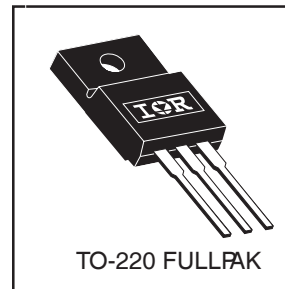

Absolute Maximum Ratings

	Parameter	Max.	Units
$I_D @ T_C = 25^\circ C$	Continuous Drain Current, $V_{GS} @ 10V$	40	A
$I_D @ T_C = 100^\circ C$	Continuous Drain Current, $V_{GS} @ 10V$	29	
I_{DM}	Pulsed Drain Current ①⑥	210	
$P_D @ T_C = 25^\circ C$	Power Dissipation	54	W
	Linear Derating Factor	0.36	W/°C
V_{GS}	Gate-to-Source Voltage	± 20	V
E_{AS}	Single Pulse Avalanche Energy②⑥	270	mJ
I_{AR}	Avalanche Current①⑥	32	A
E_{AR}	Repetitive Avalanche Energy①	5.4	mJ
dv/dt	Peak Diode Recovery dv/dt ③⑥	5.0	V/ns
T_J	Operating Junction and Storage Temperature Range	-55 to + 175	°C
T_{STG}			
	Mounting torque, 6-32 or M3 srew	10 lbf•in (1.1N•m)	

Thermal Resistance

	Parameter	Typ.	Max.	Units
$R_{\theta JC}$	Junction-to-Case	---	2.8	°C/W
$R_{\theta JA}$	Junction-to-Ambient	---	65	

IRFIZ48NPbF



Electrical Characteristics @ T_J = 25°C (unless otherwise specified)

	Parameter	Min.	Typ.	Max.	Units	Conditions
V _{(BR)DSS}	Drain-to-Source Breakdown Voltage	55	—	—	V	V _{GS} = 0V, I _D = 250μA
ΔV _{(BR)DSS/ΔT_J}	Breakdown Voltage Temp. Coefficient	—	0.052	—	V/°C	Reference to 25°C, I _D = 1mA④
R _{DS(on)}	Static Drain-to-Source On-Resistance	—	—	0.016	Ω	V _{GS} = 10V, I _D = 22A ④
V _{GS(th)}	Gate Threshold Voltage	2.0	—	4.0	V	V _{DS} = V _{GS} , I _D = 250μA
g _{fs}	Forward Transconductance	22	—	—	S	V _{DS} = 25V, I _D = 32A⑥
I _{DSS}	Drain-to-Source Leakage Current	—	—	25	μA	V _{DS} = 55V, V _{GS} = 0V
		—	—	250		V _{DS} = 44V, V _{GS} = 0V, T _J = 150°C
I _{GSS}	Gate-to-Source Forward Leakage	—	—	100	nA	V _{GS} = 20V
	Gate-to-Source Reverse Leakage	—	—	-100		V _{GS} = -20V
Q _g	Total Gate Charge	—	—	89	nC	I _D = 32A
Q _{gs}	Gate-to-Source Charge	—	—	20		V _{DS} = 44V
Q _{gd}	Gate-to-Drain ("Miller") Charge	—	—	39		V _{GS} = 10V, See Fig. 6 and 13 ④⑥
t _{d(on)}	Turn-On Delay Time	—	11	—	ns	V _{DD} = 28V
t _r	Rise Time	—	78	—		I _D = 32A
t _{d(off)}	Turn-Off Delay Time	—	32	—		R _G = 5.1Ω
t _f	Fall Time	—	48	—		R _D = 0.85Ω, See Fig. 10 ④⑥
L _D	Internal Drain Inductance	—	4.5	—	nH	Between lead, 6mm (0.25in.) from package and center of die contact
L _S	Internal Source Inductance	—	7.5	—		
C _{iss}	Input Capacitance	—	1900	—	pF	V _{GS} = 0V
C _{oss}	Output Capacitance	—	620	—		V _{DS} = 25V
C _{rss}	Reverse Transfer Capacitance	—	270	—		f = 1.0MHz, See Fig. 5⑥
C	Drain to Sink Capacitance	—	12	—		f = 1.0MHz

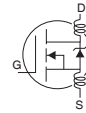

Source-Drain Ratings and Characteristics

	Parameter	Min.	Typ.	Max.	Units	Conditions
I _S	Continuous Source Current (Body Diode)	—	—	49	A	MOSFET symbol showing the integral reverse p-n junction diode.
I _{SM}	Pulsed Source Current (Body Diode) ①⑥	—	—	210		
V _{SD}	Diode Forward Voltage	—	—	1.3	V	T _J = 25°C, I _S = 22A, V _{GS} = 0V ④
t _{rr}	Reverse Recovery Time	—	94	140	ns	T _J = 25°C, I _F = 32A
Q _{rr}	Reverse Recovery Charge	—	360	540	nC	di/dt = 100A/μs ④⑥

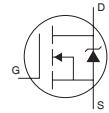

Notes:

- ① Repetitive rating; pulse width limited by max. junction temperature. (See fig. 11)
- ② V_{DD} = 25V, starting T_J = 25°C, L = 530μH
R_G = 25Ω, I_{AS} = 32A. (See Figure 12)
- ③ I_{SD} ≤ 32A, di/dt ≤ 250A/μs, V_{DD} ≤ V_{(BR)DSS},
T_J ≤ 175°C
- ④ Pulse width ≤ 300μs; duty cycle ≤ 2%.
- ⑤ t = 60s, f = 60Hz
- ⑥ Uses IRFZ48N data and test conditions



IRFIZ48NPbF

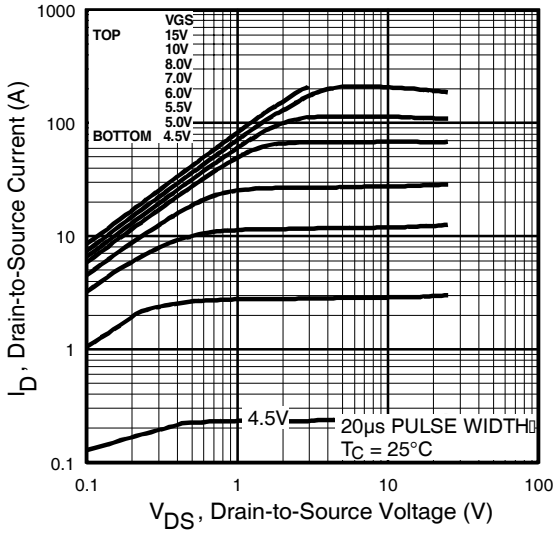

Fig 1. Typical Output Characteristics

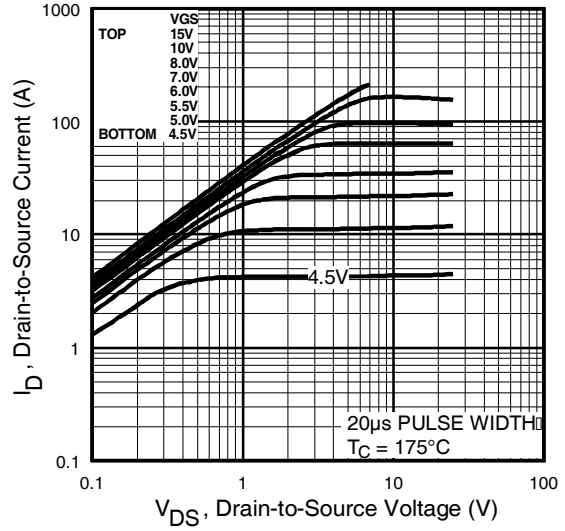

Fig 2. Typical Output Characteristics

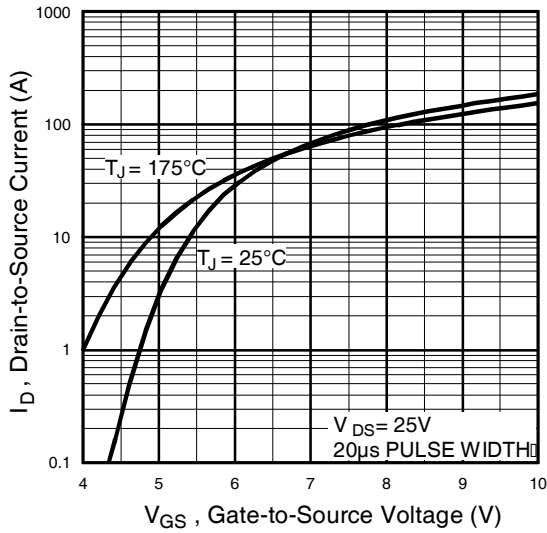

Fig 3. Typical Transfer Characteristics

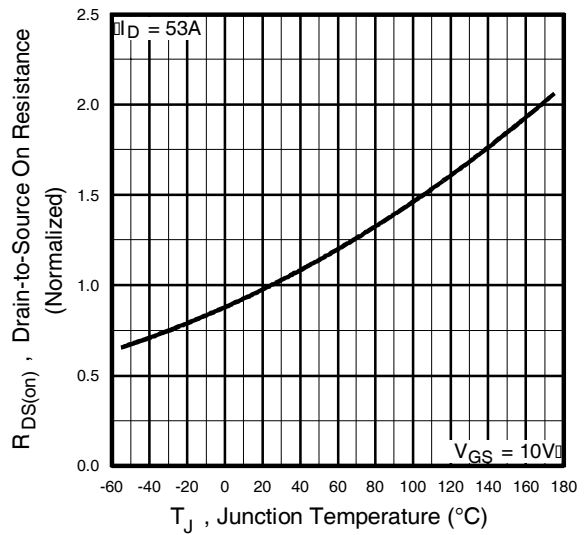

Fig 4. Normalized On-Resistance Vs. Temperature

IRFIZ48NPbF

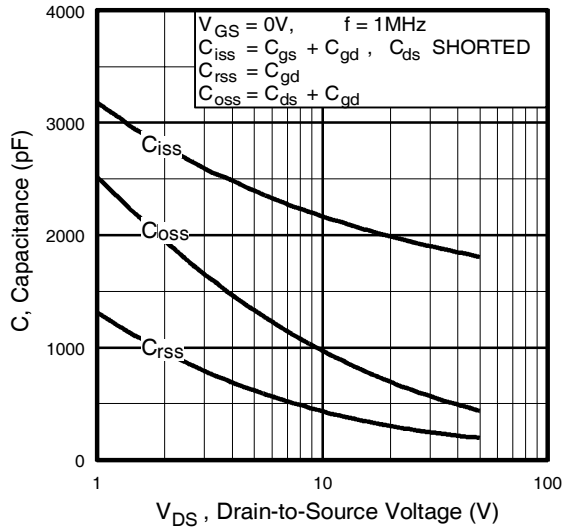

Fig 5. Typical Capacitance Vs. Drain-to-Source Voltage

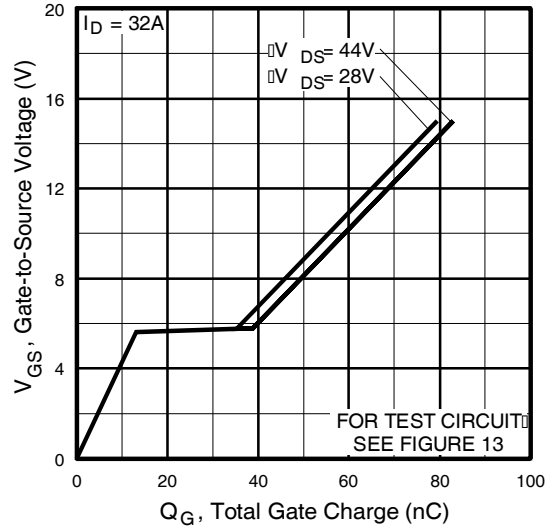

Fig 6. Typical Gate Charge Vs. Gate-to-Source Voltage

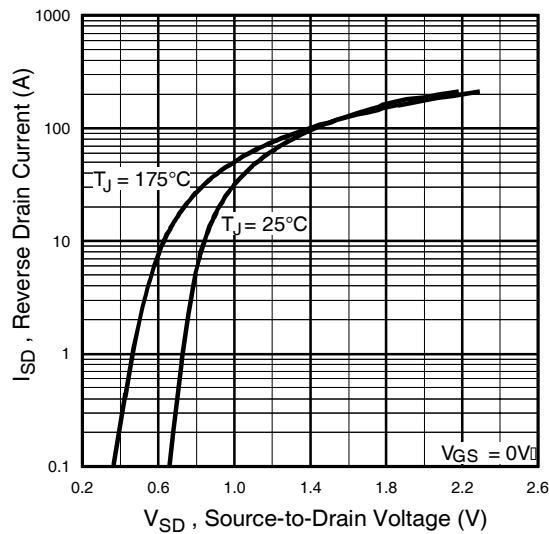

Fig 7. Typical Source-Drain Diode Forward Voltage

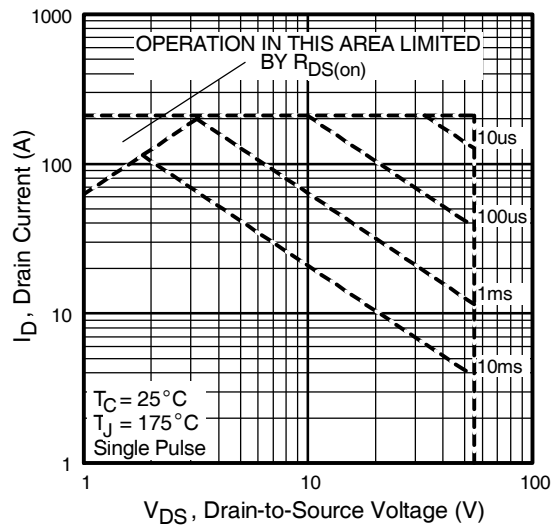

Fig 8. Maximum Safe Operating Area



IRFIZ48NPbF

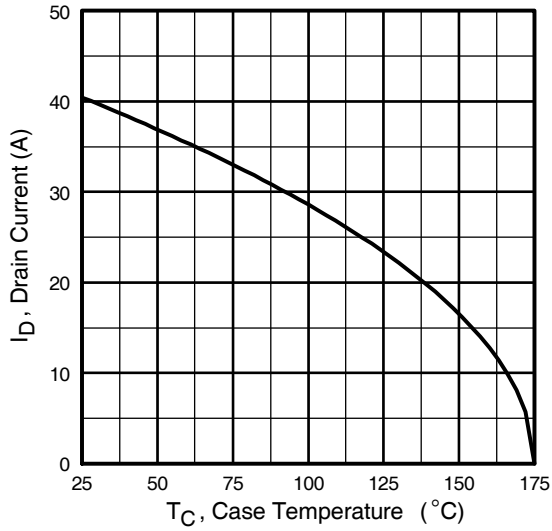

Fig 9. Maximum Drain Current Vs. Case Temperature

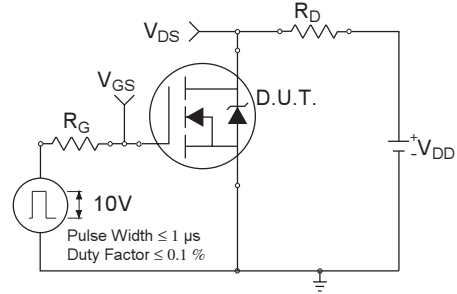

Fig 10a. Switching Time Test Circuit

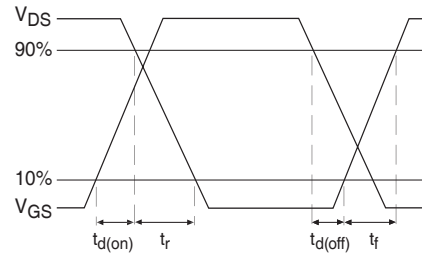

Fig 10b. Switching Time Waveforms

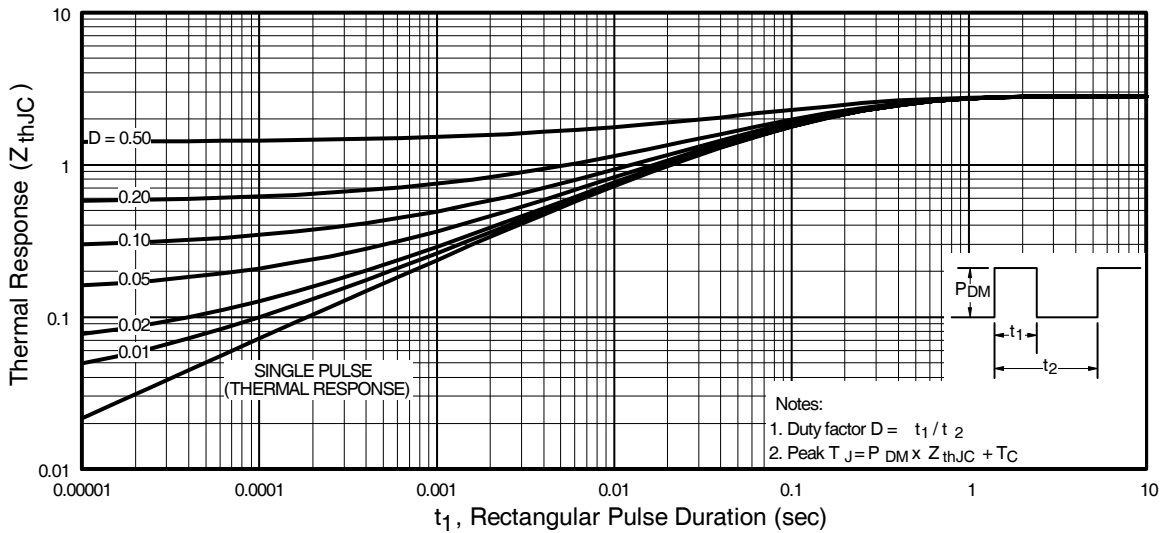

Fig 11. Maximum Effective Transient Thermal Impedance, Junction-to-Case

IRFIZ48NPbF

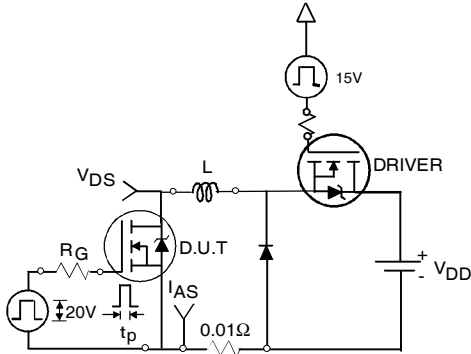

Fig 12a. Unclamped Inductive Test Circuit

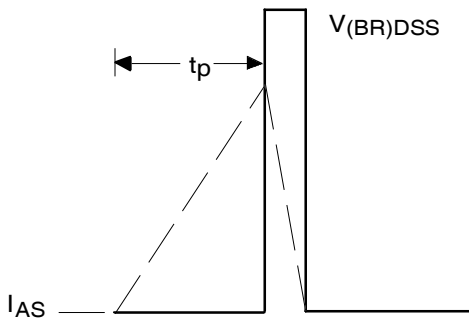

Fig 12b. Unclamped Inductive Waveforms

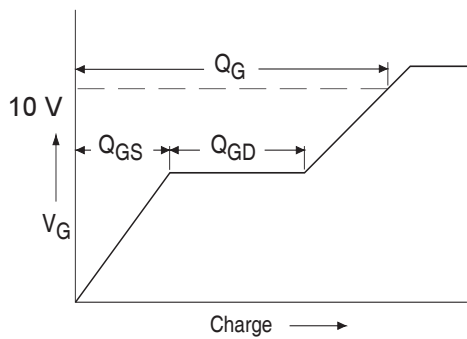

Fig 13a. Basic Gate Charge Waveform

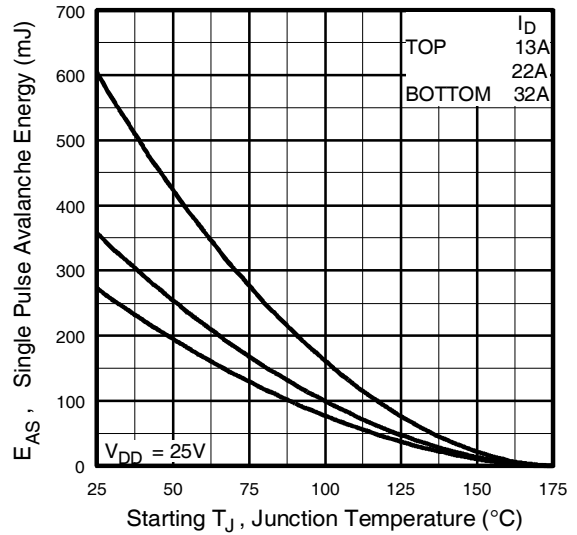

Fig 12c. Maximum Avalanche Energy Vs. Drain Current

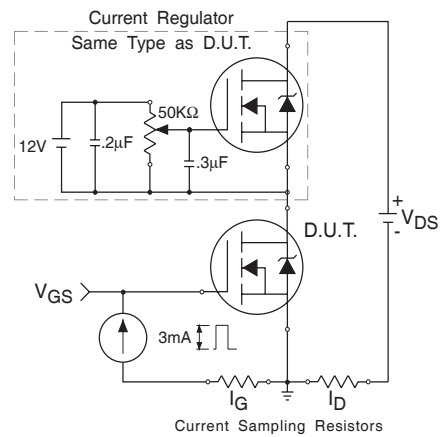
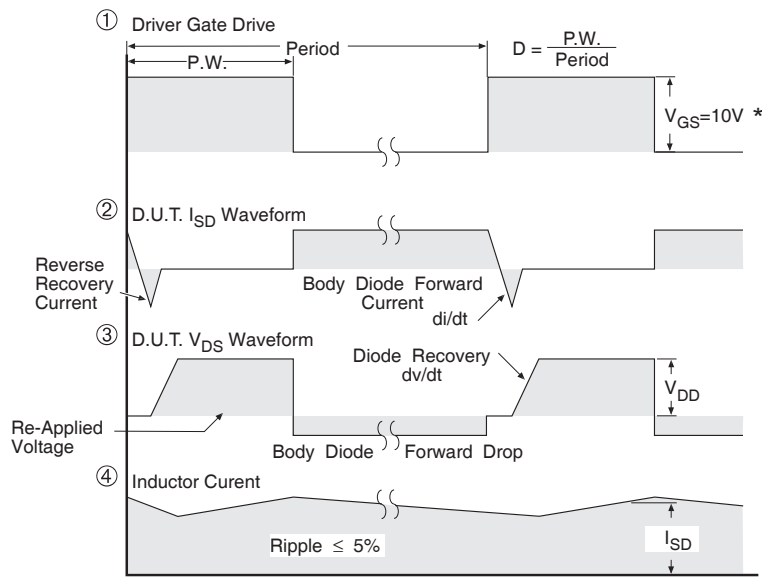

Fig 13b. Gate Charge Test Circuit



IRFIZ48NPbF

Peak Diode Recovery dv/dt Test Circuit



* $V_{GS} = 5V$ for Logic Level Devices

Fig 14. For N-Channel HEXFETS

IRFIZ48NPbF



TO-220 Full-Pak Package Outline

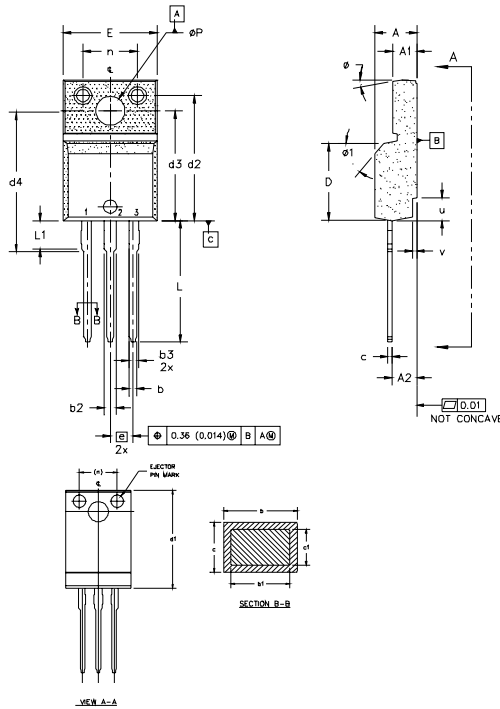

- NOTES:
- 1.0 DIMENSIONING AND TOLERANCING PER ASME Y14.5 M- 1994.
 - 2.0 DIMENSIONS ARE SHOWN IN MILLIMETERS [INCHES].
 - 3.0 LEAD DIMENSION AND FINISH UNCONTROLLED IN L1.
 - 4.0 DIMENSION D & E DO NOT INCLUDE MOLD FLASH. MOLD FLASH SHALL NOT EXCEED 0.005" (0.127) PER SIDE. THESE DIMENSIONS ARE MEASURED AT THE OUTERMOST EXTREMES OF THE PLASTIC BODY.
 - 5.0 DIMENSION b1 APPLY TO BASE METAL ONLY.
 - 6.0 STEP OPTIONAL ON PLASTIC BODY DEFINED BY DIMENSIONS u & v.
 - 7.0 CONTROLLING DIMENSION : INCHES.

SYMBOL	DIMENSIONS		DIMENSIONS		NOTES
	MILLIMETERS	MILLIMETERS	INCHES	INCHES	
A	4.57	4.83	0.180	0.190	
A1	2.57	2.85	0.101	0.114	
A2	2.51	2.85	0.099	0.112	
b	0.622	0.89	0.024	0.035	
b1	0.622	0.838	0.024	0.033	5
b2	1.229	1.400	0.048	0.055	
b3	1.229	1.400	0.048	0.055	
c	0.440	0.629	0.017	0.025	
c1	0.440	0.584	0.017	0.023	
D	8.65	9.80	0.341	0.386	
d1	15.80	16.12	0.622	0.635	
d2	13.97	14.22	0.550	0.560	
d3	12.30	12.92	0.484	0.509	
d4	8.64	9.91	0.340	0.390	
E	10.35	10.63	0.408	0.419	
e	2.54 BSC		0.100 BSC		4
L	13.20	13.73	0.520	0.541	
L1	3.10	3.90	0.122	0.138	3
n	6.05	6.15	0.238	0.242	
p	3.05	3.45	0.120	0.136	
u	2.40	2.50	0.094	0.098	6
v	0.40	0.50	0.016	0.020	6
w	3°	7°	3°	7°	
x1		45°		45°	

- LEAD ASSIGNMENTS
- HEXFET
 - 1- GATE
 - 2- DRAIN
 - 3- SOURCE
- IGBTs, CoPACK
- 1- GATE
 - 2- COLLECTOR
 - 3- EMITTER

TO-220 Full-Pak Part Marking Information

EXAMPLE: THIS IS AN IRF1840G
 WITH ASSEMBLY
 LOT CODE 3432
 ASSEMBLED ON WW 24 1999
 IN THE ASSEMBLY LINE "K"

Note: "P" in assembly line position indicates "Lead-Free"

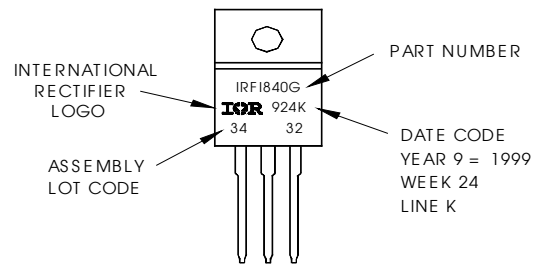

Data and specifications subject to change without notice.



IR WORLD HEADQUARTERS: 233 Kansas St., El Segundo, California 90245, USA Tel: (310) 252-7105
 TAC Fax: (310) 252-7903
 Visit us at www.irf.com for sales contact information.11/03

Note: For the most current drawings please refer to the IR website at:
<http://www.irf.com/package/>