



Normally closed type in a slim SIL package Load voltage 400V	PhotoMOS® Power 1 Form B (AQZ404)
---	--

FEATURES

- 1. High sensitivity and low on-resistance**
Max. 0.5A load can be controlled with 5 mA input current. The on-resistance is low at typ. 2.8Ω.
- 2. Normally closed (1 Form B) contact**
This has been realized thanks to the built-in MOSFET processed by our proprietary method, DSD (Double-diffused and Selective Doping) method.

- 3. Slim SIL4-pin package**
(W) 3.5 × (D) 21.0 × (H) 12.5 mm
(W) .138 × (D) .827 × (H) .492 inch
The compact size of the 4-pin SIL package allows high density mounting.
- 4. Sockets are also available**
(PA1a-PS, PA1a-PS-H)
- 5. Can be installed on the RT-3 relay terminal (Power PhotoMOS type)**

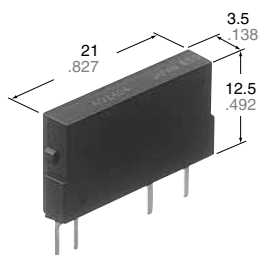

(Height includes standoff)

mm inch

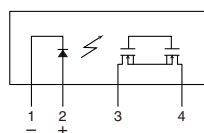

RoHS compliant

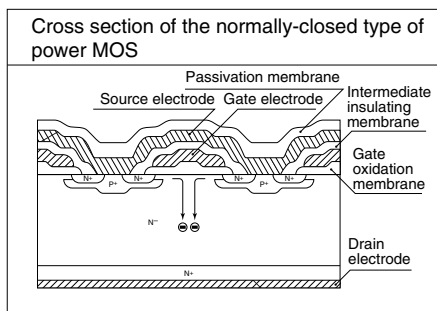

TYPICAL APPLICATIONS

- Traffic signals
- Measuring instruments
- Industrial machines

TYPES

	Output rating*		Package	Part No.	Packing quantity	
	Load voltage	Load current			Inner carton	Outer carton
AC/DC dual use	400 V	0.5 A	SIL4-pin	AQZ404	25 pcs	500 pcs

*Indicate the peak AC and DC values.

RATING

1. Absolute maximum ratings (Ambient temperature: 25°C 77°F)

Item		Symbol	AQZ404	Remarks
Input	LED forward current	I _F	50 mA	
	LED reverse voltage	V _R	5 V	
	Peak forward current	I _{FP}	1 A	f = 100 Hz, Duty factor = 0.1%
	Power dissipation	P _{in}	75 mW	
Output	Load voltage (peak AC)	V _L	400 V	
	Continuous load current	I _L	0.5 A	Peak AC, DC
	Peak load current	I _{peak}	1.5 A	100 ms (1 shot), V _L = DC
	Power dissipation	P _{out}	1.6 W	
Total power dissipation		P _T	1.6 W	
I/O isolation voltage		V _{iso}	2,500 V AC	
Temperature limits	Operating	T _{opr}	-40°C to +85°C -40°F to +185°F	Non-condensing at low temperatures
	Storage	T _{stg}	-40°C to +100°C -40°F to +212°F	

Power 1 Form B (AQZ404)

2. Electrical characteristics (Ambient temperature: 25°C 77°F)

Item		Symbol	AQZ404	Condition	
Input	LED operate (OFF) current	Typical	1.0 mA	$I_L = 100 \text{ mA}$ $V_L = 10 \text{ V}$	
		Maximum	3.0 mA		
	LED reverse (ON) current	Minimum	0.4 mA	$I_L = 100 \text{ mA}$ $V_L = 10 \text{ V}$	
		Typical	0.9 mA		
LED dropout voltage	Typical	1.25 V (1.16 V at $I_F = 10 \text{ mA}$)		$I_F = 50 \text{ mA}$	
	Maximum	1.5 V			
Output	On resistance	Typical	2.8 Ω	$I_F = 0 \text{ mA}$, $I_L = \text{Max.}$ Within 1 s on time	
		Maximum	4.0 Ω		
	Off state leakage current	Maximum	I_{Leak}	10 μA	$I_F = 10 \text{ mA}$, $V_L = \text{Max.}$
Transfer characteristics	Operating (OFF) time*	Typical	3.9 ms	$I_F = 0 \rightarrow 10 \text{ mA}$ $I_L = 100 \text{ mA}$, $V_L = 10 \text{ V}$	
		Maximum	7.5 ms		
		Typical	9.4 ms	$I_F = 0 \rightarrow 5 \text{ mA}$ $I_L = 100 \text{ mA}$, $V_L = 10 \text{ V}$	
		Maximum	15 ms		
	Reverse (ON) time*	Typical	0.8 ms	$I_F = 5 \text{ mA} \rightarrow 0$ or $10 \text{ mA} \rightarrow 0$ $I_L = 100 \text{ mA}$, $V_L = 10 \text{ V}$	
		Maximum	3.0 ms		
	I/O capacitance	Typical	C_{iso}	0.8 pF	$f = 1 \text{ MHz}$ $V_B = 0 \text{ V}$
		Maximum		1.5 pF	
Initial I/O isolation resistance	Minimum	R_{iso}	1,000 M Ω	500 V DC	
Maximum operating frequency	Maximum	—	0.5 cps	$I_F = 10 \text{ mA}$, Duty factor = 50% $I_L = \text{Max.}$, $V_L = \text{Max.}$	

*Operate/Reverse time

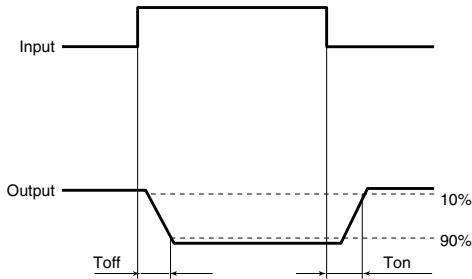

RECOMMENDED OPERATING CONDITIONS

Please obey the following conditions to ensure proper device operation and resetting.

Item	Symbol	Recommended value	Unit
Input LED current	I_F	5 to 10	mA

■ These products are not designed for automotive use.

If you are considering to use these products for automotive applications, please contact your local Panasonic Corporation technical representative.

REFERENCE DATA

1. Load current vs. ambient temperature characteristics

Allowable ambient temperature: -40°C to +85°C
-40°F to +185°F

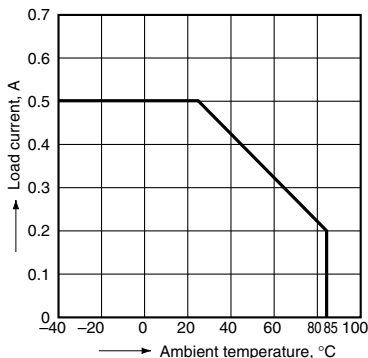

2. Load current vs. ambient temperature characteristics in adjacent mounting

I_L : Load current;
 $I_L (\text{max.})$: Maximum continuous load current

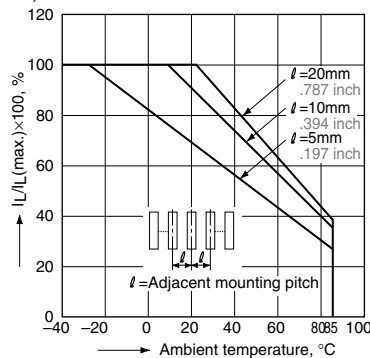

3. On resistance vs. ambient temperature characteristics

LED current: 0 mA; Load voltage: Max. (DC)
Continuous load current: Max. (DC)

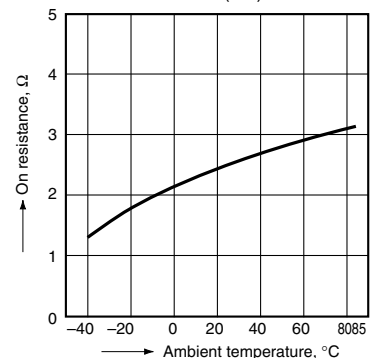

4. Operate (OFF) time vs. ambient temperature characteristics

LED current: 10 mA; Load voltage: 10 V (DC); Continuous load current: 100 mA (DC)

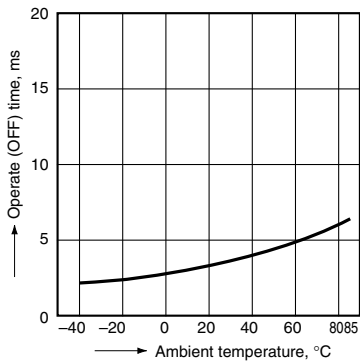

5. Reverse (ON) time vs. ambient temperature characteristics

LED current: 10 mA; Load voltage: 10 V (DC); Continuous load current: 100 mA (DC)

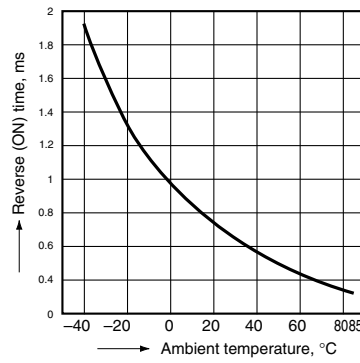

6. LED operate (OFF) current vs. ambient temperature characteristics

Load voltage: 10 V (DC); Continuous load current: 100 mA (DC)

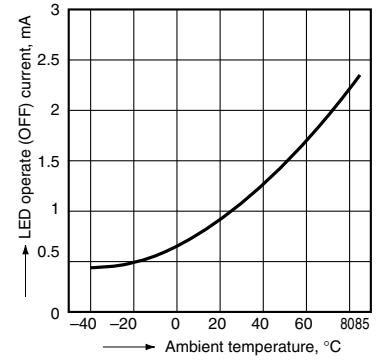

7. LED reverse (ON) current vs. ambient temperature characteristics

Load voltage: 10 V (DC); Continuous load current: 100 mA (DC)

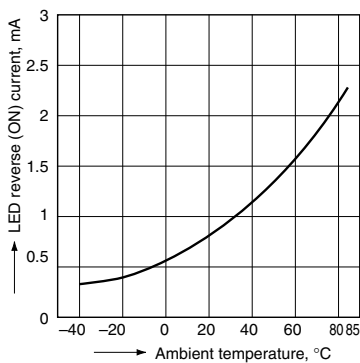

8. LED dropout voltage vs. ambient temperature characteristics

Sample: all types; LED current: 5 to 50 mA

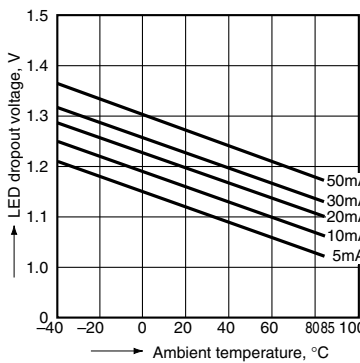

9. Current vs. voltage characteristics of output at MOS portion

Ambient temperature: 25°C 77°F

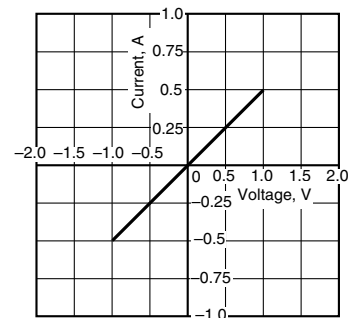

10. Off state leakage current vs. load voltage characteristics

LED current: 10 mA; Ambient temperature: 25°C 77°F

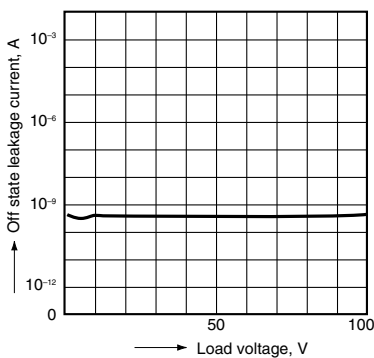

11. Operate (OFF) time vs. LED forward current characteristics

Load voltage: 10 V (DC); Continuous load current: 100 mA (DC); Ambient temperature: 25°C 77°F

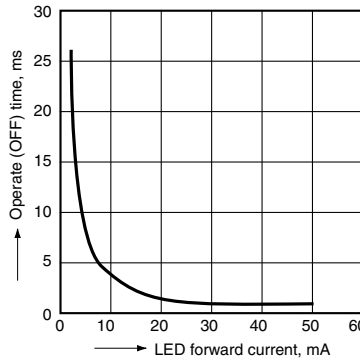

12. Reverse (ON) time vs. LED forward current characteristics

Load voltage: 10 V (DC); Continuous load current: 100 mA (DC); Ambient temperature: 25°C 77°F

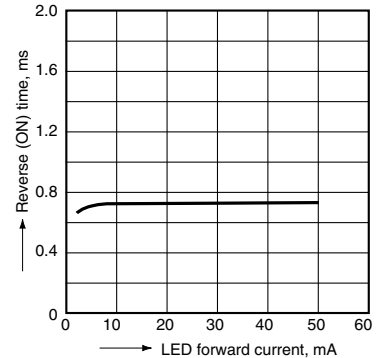

13. Maximum operating frequency vs. load voltage/current characteristics

LED current: 10 mA; Ambient temperature: 25°C 77°F

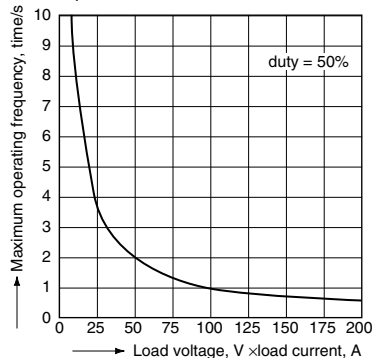

14. Output capacitance vs. applied voltage characteristics

LED current: 10 mA; Frequency: 1 MHz; Ambient temperature: 25°C 77°F

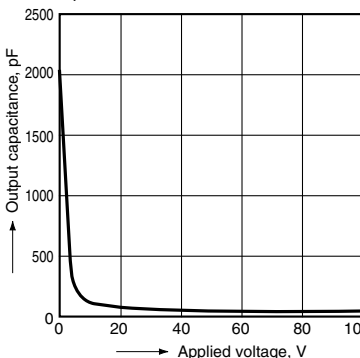

ACCESSORY (mm inch)

Socket



Standard type

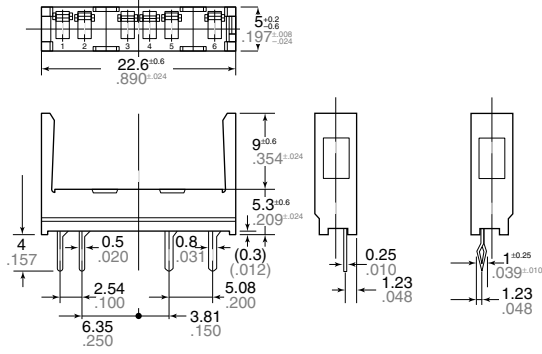

PA1a-PS

General Tolerance: $\pm 0.3 \pm 0.012$

Self clinching type

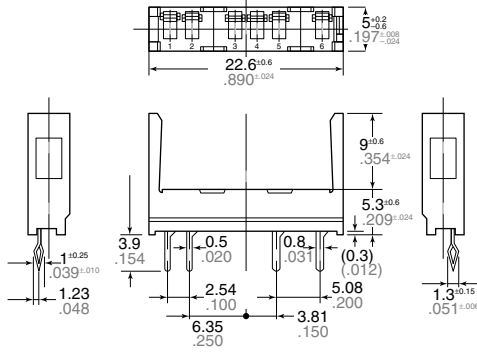

PA1a-PS-H

General Tolerance: $\pm 0.3 \pm 0.012$

PC board pattern
(BOTTOM VIEW)

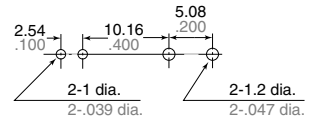

Self clinching type

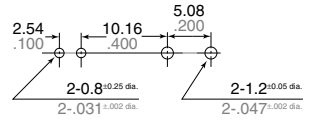

Tolerance: $\pm 0.1 \pm 0.004$