

\*RoHS COMPLIANT

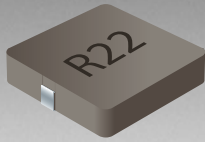

**BOURNS®**

### Features

- Shielded construction
- Flat wire
- Unit height of 1.2 mm
- Inductance range: 0.22 to 1.5  $\mu$ H
- Rated current up to 9 A
- RoHS compliant\* and halogen free\*\*



This series is currently available but not recommended for new designs. The newer **Model SRP4012TA** series is recommended.

## SRP4012 Series - Shielded Power Inductors

### Electrical Specifications

Bourns Part No.	Inductance L ( $\mu$ H) $\pm 20\%$	I rms (A)	I sat (A)	DCR (m $\Omega$ ) Max.
SRP4012-R22M	0.22	9	10	9.3
SRP4012-R47M	0.47	6.5	9	20
SRP4012-R56M	0.56	5.5	8	25
SRP4012-1R0M	1.0	4.8	6.3	33.6
SRP4012-1R2M	1.2	3	6	45
SRP4012-1R5M	1.5	3	5.5	50

### Soldering Profile

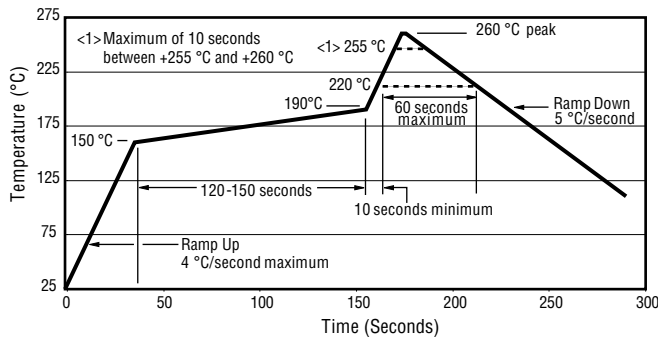

### Electrical Schematic

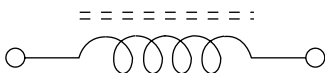

### Recommended Layout

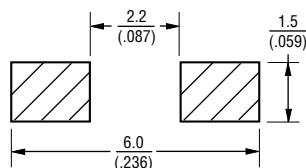

### General Specifications

Test Voltage .....0.25 V  
 Test Frequency ..... 100 KHz  
 Reflow Soldering .. 230 °C; 50 sec. max.  
 Operating Temperature  
 .....-55 °C to +125 °C  
 (Temperature rise included)  
 Storage Temperature  
 .....-55 °C to +125 °C  
 Resistance to Soldering Heat  
 .....+260 °C for 10 sec.

### Materials

Core .....Iron  
 Wire .....Enameled copper  
 Terminal ..... Cu/Sn  
 Rated Current .... Ind. drops 20 % at Isat  
 Temperature Rise .....40 °C at rated I rms  
 Packaging ..... 2000 pcs. per 13-inch reel

### Product Dimensions

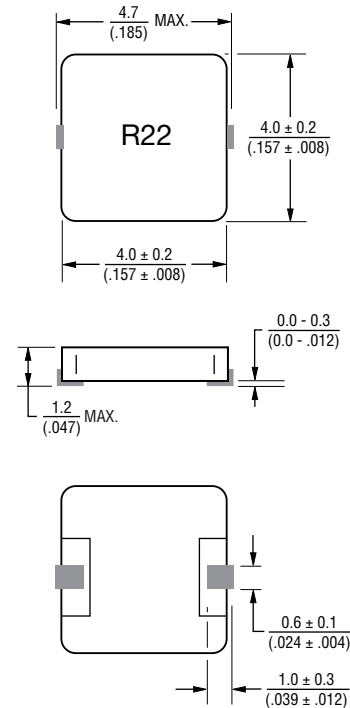

DIMENSIONS:  $\frac{\text{MM}}{\text{(INCHES)}}$

**BOURNS®**

Asia-Pacific: Tel: +886-2 2562-4117 • Email: asiacus@bourns.com

EMEA: Tel: +36 88 520 390 • Email: eurocus@bourns.com

The Americas: Tel: +1-951 781-5500 • Email: americus@bourns.com

www.bourns.com

\* RoHS Directive 2002/95/EC Jan. 27, 2003 including annex and RoHS Recast 2011/65/EU June 8, 2011.

\*\*Bourns considers a product to be "halogen free" if (a) the Bromine (Br) content is 900 ppm or less; (b) the Chlorine (Cl) content is 900 ppm or less; and (c) the total Bromine (Br) and Chlorine (Cl) content is 1500 ppm or less. Specifications are subject to change without notice.

The device characteristics and parameters in this data sheet can and do vary in different applications and actual device performance may vary over time. Users should verify actual device performance in their specific applications.

## Applications

- DC/DC converters
- Power supplies for:
  - Portable communications equipment
  - Laptop computers
  - Camcorders, HDTV, car audio systems
  - Video game consoles

# SRP4012 Series - Shielded Power Inductors

**BOURNS®**

### L vs. I Charts

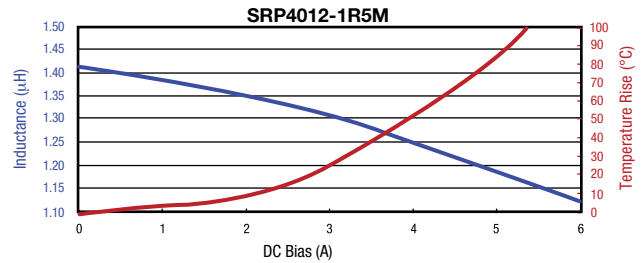
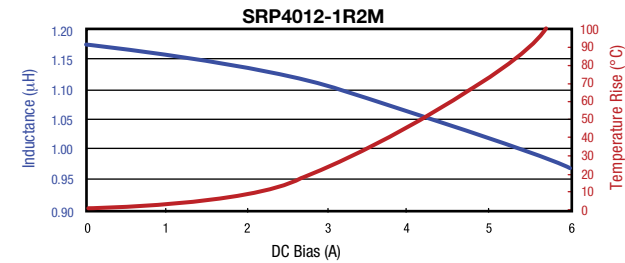
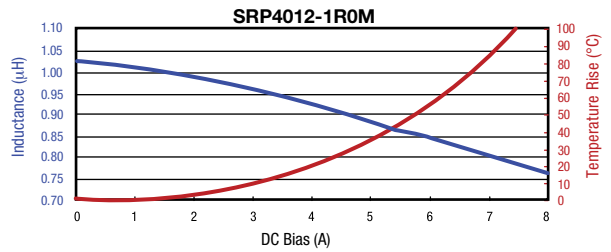
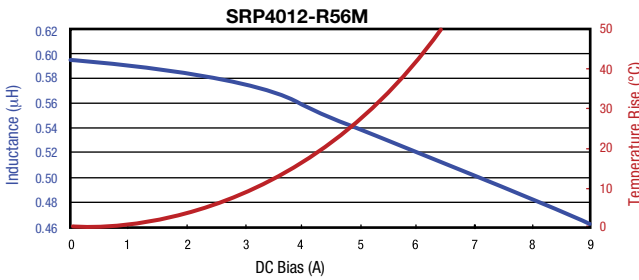
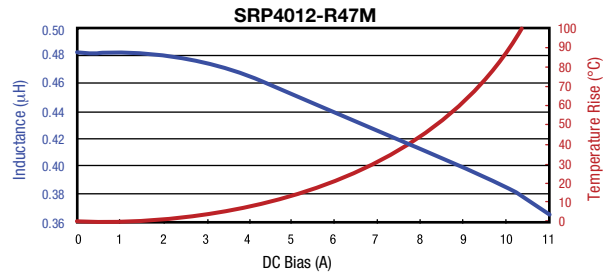
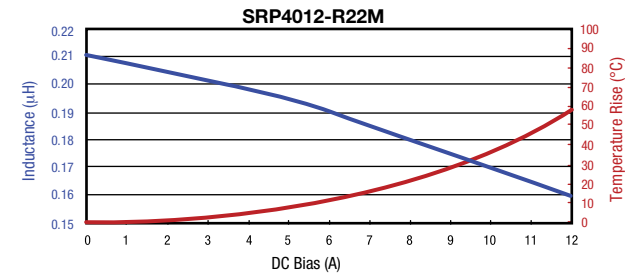

Specifications are subject to change without notice.

The device characteristics and parameters in this data sheet can and do vary in different applications and actual device performance may vary over time. Users should verify actual device performance in their specific applications.

# SRP4012 Series - Shielded Power Inductors

**BOURNS®**

## Packaging Specifications

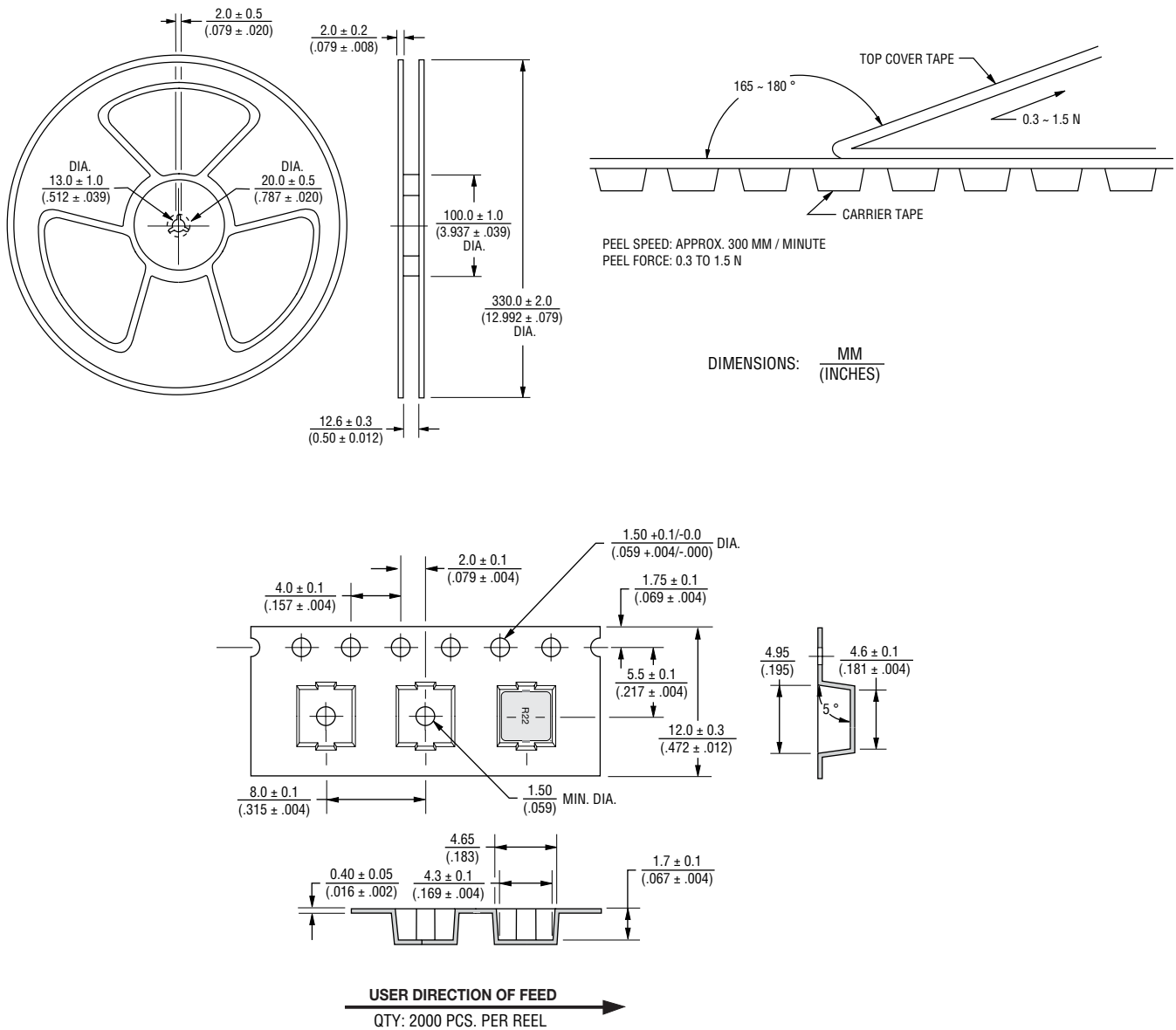

REV. 01/17

Specifications are subject to change without notice.

The device characteristics and parameters in this data sheet can and do vary in different applications and actual device performance may vary over time. Users should verify actual device performance in their specific applications.