

125 Series FTS250

Disciplined Reference and Synchronous Clock Generator



2111 Comprehensive Drive
Aurora, Illinois 60505
Phone: 630-851-4722
Fax: 630-851-5040
www.conwin.com

D A T A S H E E T

General Description

The FTS250-010.0M Frequency and Time Standard module is a GPS driven, mixed-signal phase lock loop, providing a 1 PPS CMOS output from a Connor-Winfield GPS timing receiver and generating a 10 MHz CMOS and a 10 MHz SINE output from an intrinsically low jitter voltage controlled crystal oscillator. The FTS250 can lock to a 10 MHz reference derived from the on-board GPS receiver or an external 10 MHz reference or to an external 1 PPS reference. Alarms are provided to indicate Loss-of-Lock, Holdover, and Antenna Fault. The on-board GPS receiver requires an outdoor mounted GPS antenna for the best stability and consistent performance.

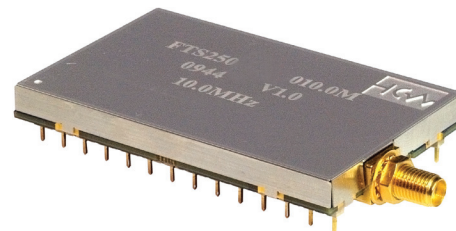

The mode control inputs are used to manually switch between references and/or holdover. The user application should monitor the alarm outputs and manually switch modes as needed.

Serial I/O lines provide access to the NMEA messages from the GPS receiver (referenced in the Connor-Winfield's Wi125 User Manual. Contact Connor-Winfield Sales for a copy). The serial I/O lines can be used to access GPS timestamp information, or to verify that the receiver has recovered from an alarm condition. The reset is used to reset the GPS receiver (if needed).

Features

- Phase locked 10 MHz output
- 1 PPS output
- 3 selectable references: GPS, External 10 MHz or External 1 PPS
- Holdover
- Three alarm outputs. (Loss-of-Lock, Holdover and Antenna Fault)
- Serial input and output ports (GPS receiver)
- Master reset
- +3.3 Volt power supply
- Temperature Range: -40°C to 85°C
- Meets ITU-T G.811 Wander Generation Mask
- SMA Bulkhead GPS Antenna Connection
- Package: 28-pin Through-Hole
- Physical Dimensions: 2.8" x 1.725" x 0.368" (71mm x 43.82mm x 9.34mm)
- Fixed Position Unit

Functional Block Diagram

Figure 1

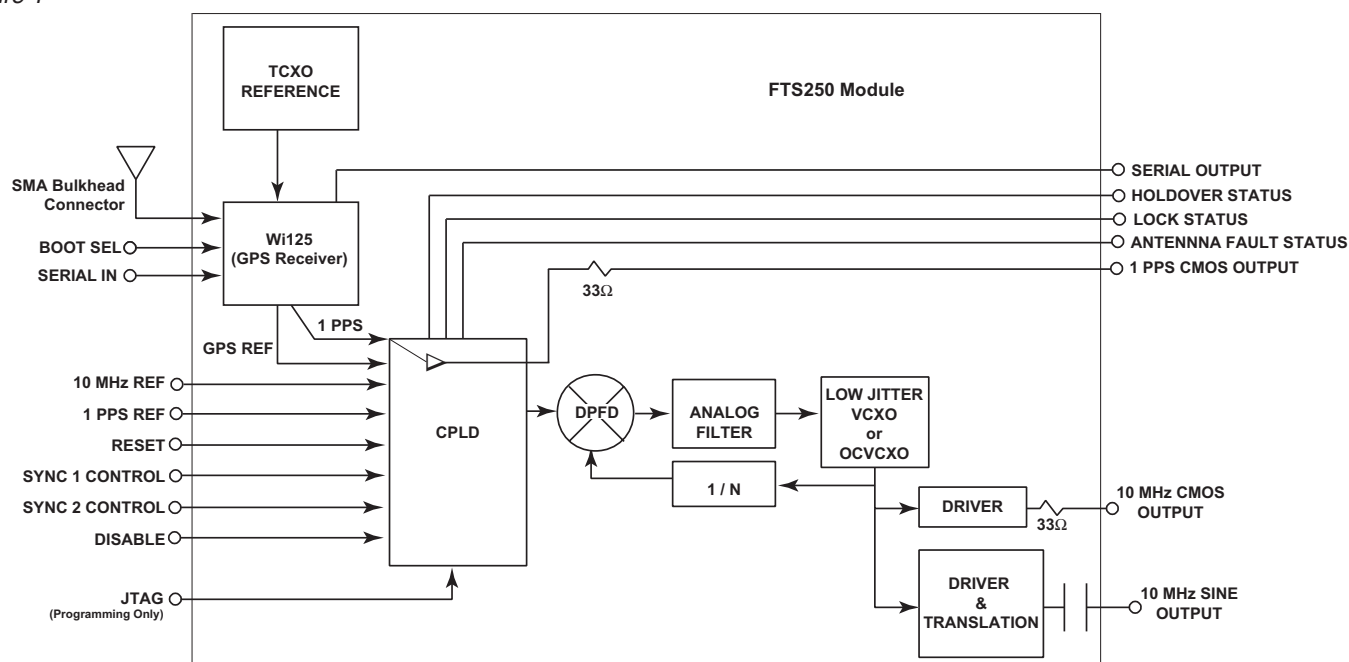

Pin Description

Table 1

Pin #	Pin Name	Description	Note
1	Vcc2	3.3V ±5% Supply Voltage for PLL and Interfacing Circuitry	1
2	GND		
3	*Reset	Hardware Reset for GPS Circuitry. Pull low to Reset	2
4	*Disable	Open/High = Enabled Outputs. Low = Disabled Outputs	2
5	1 PPS Ref Input	External 1 PPS reference	2
6	GND		
7	10 MHz Ref Input	External LVCMOS 10 MHz Reference	2
8	NU	Used for Factory Programming	
9	NU	Used for Factory Programming	
10	NU	Used for Factory Programming	
11	NU	Used for Factory Programming	
12	*Bootsel	Normally High - Pulled low during Wi125 software updates	
13	GND		
14	Vcc1	3.3V ±5% Supply Voltage GPS Timing Circuitry	
15	Antenna Supply Voltage	2.7 to 13.2V Input Supply Voltage for the Antenna. Max 45mA continuous current	
16	GND		
17	RXA	RS-232 Communication receive signal for UART-0	
18	TXA	RS-232 Communication transmit signal for UART-0	
19	SYNC2 Control	Lock mode selection control signal 2	2
20	SYNC1 Control	Lock mode selection control signal 1	2
21	Lock Status	High = Unit is locked to the selected reference	2
22	Holdover Status	High = Unit is in Holdover	2
23	Antenna Fault Status	High = Fault detected on the Antenna Supply Voltage (Self Clearing)	2
24	1 PPS CMOS Output	1 PPS LVCMOS Output	2
25	GND		
26	10 MHz CMOS Output	10 MHz LVCMOS Output	2
27	GND		
28	10 MHz SINE Output	10 MHz Sine Output (~9dBm)	

Note: 1. Provide a clean supply to this pin. Connecting to Vcc1 will degrade phase noise.
 2. 3.3 VDC (LVCMOS) compatible.

Absolute Maximum Rating

Table 2

Symbol	Parameter	Minimum	Maximum	Units	Notes
V _{CC}	Power Supply Voltage	-0.3	3.7	Volts	1
V _{IN}	Input Voltage	-0.3	4.6	Volts	1
V _{PREAMP}	Antenna Supply Voltage	2.7	13.2	Volts	1
T _S	Storage Temperature	-30	80	°C	1

Operating Specifications

Table 3

Symbol	Parameter	Minimum	Nominal	Maximum	Units	Notes
V _{CC1}	Supply Voltage 1	3.135	3.3	3.465	V	2
I _{CC1}	Supply Current 1		0.200		A	
V _{CC2}	Supply Voltage 2	3.135	3.3	3.465	V	2
I _{CC2}	Supply Current 2		0.036		A	
T _O	Temperature Range	-40		85	°C	
t _{JTOL}	Input Jitter Tolerance	30			ns	
t _{AQ_GPS}	GPS Input Acquisition Time		100		sec	3
t _{AQ_EXT}	External Input Acquisition Time		100		sec	3
Oscillator Performance						
F _{CAP}	Capture/Pull-in Range		±10		ppm	
F _{BW}	Jitter Filter Bandwidth		0.8		Hz	
DC	Duty Cycle		45/55		%	
RMS	RMS Phase Noise					
	10 Hz - 2 MHz		1.2		ps	
	12 kHz - 2 MHz		0.6			
Holdover/Wander Generation Performance						4
	Frequency Stability		±0.32		ppm	5
	Wander Generation Specification		ITU-T G.811			

NOTES:

1. Stresses beyond those listed under "Absolute Maximum Rating" may cause permanent damage to the module. These are stress ratings only and functional operation of the device at these or any other conditions beyond those indicated under "Operating Specifications" is not implied. Exposure to absolute maximum rated conditions for extended periods may affect device reliability.
2. Requires external regulation and supply decoupling.
3. Cold Power-up.
4. Holdover will be re-calculated with each successful lock. Yearly aging represents 1 continuous year in Holdover.
5. Includes unidirectional temperature stability, Vcc stability, and 24 hours of aging.

Mode Control Table

Table 4

SYNC 1	SYNC 2	Operating Mode
0	0	Force Holdover
0	1	Lock to External 10 MHz reference*
1	0	Lock to External 1 PPS reference
1	1	(Default) Lock to GPS Signal

* Note: Holdover is not supported in this mode; loss of the 10MHz reference will rail the PLL output until the reference returns or another mode is selected.

Input And Output Characteristics

Table 5

LVCMOS Inputs and Outputs					
Symbol	Parameter	Minimum	Maximum	Units	Notes
V _{IH}	High Level Input Voltage	1.7	4.0	V	
V _{IL}	Low Level Input Voltage	-0.5	0.8	V	
V _{OH}	High Level Output Voltage	2.4		V	
V _{OL}	Low Level Output Voltage		0.4	V	
C _O	Output Capacitance		10	pF	
10 MHz Sine Output					
Symbol	Parameter	Typical		Units	Notes
	Load	50		ohms	
	Output Power	9		dB _m	
	Total Harmonic Distortion	2.2		%	

GPS Receiver Specifications

Table 6

Parameter	Specifications	Notes
Acquisition/Tracking Sensitivity	-155dBm/-156dBm	
Acquisition Time:		
Hot Start w/ Network Assist	Outdoor: <2 sec Indoor: (-148dBm) <5 sec	
Stand Alone	Cold: <45 sec Warm: <38 sec Hot: <5 sec Re-acquisition: <1sec (90% confidence)	
Supported Protocols	Network Assist, NMEA 0183	

Reset Generation (I/O pin 3 - RESET)

The power-on-reset for the FTS250 is generated on-board. If it is desired to extend the power-on-reset signal or provide a manual reset of the GPS receiver, pull this signal low.

Antenna Requirements

Table 7

Parameter	Notes
The FTS250 antenna connector is a SMA Bulkhead (female)	
The antenna supply voltage provided to Pin 15 must be within the range of 2.7 to 13.2V (AMR); the antenna must be able to operate at this voltage	
The antenna's continuous current draw must be $\leq 45\text{mA}$	
The antenna must have a full sky view for optimal receiver performance	
An active antenna with a minimum 10dB gain (including cable loss) should be used	

Standard 125 Series models are designed for fixed position operation only. Contact Connor-Winfield Sales for mobile application model offerings

Phase Noise

Figure 2

Phase Noise:	
Offset Frequency (Hz)	(dBc/Hz)
10	-90 (Typ)
100	-125 (Typ)
1k	-138 (Typ)
10k	-142 (Typ)
100k	-150 (Typ)
1M	-152 (Typ)

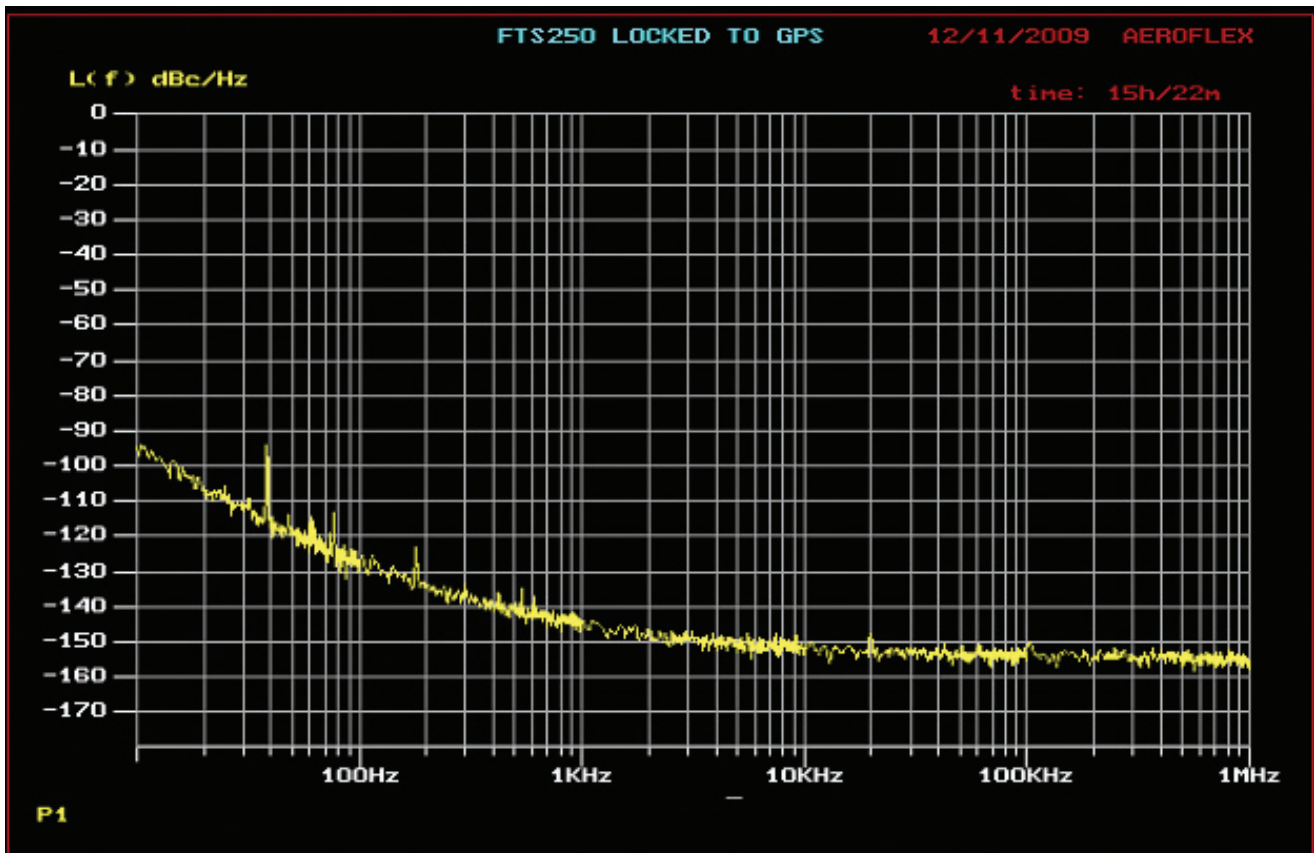

Allan Variance
Figure 3

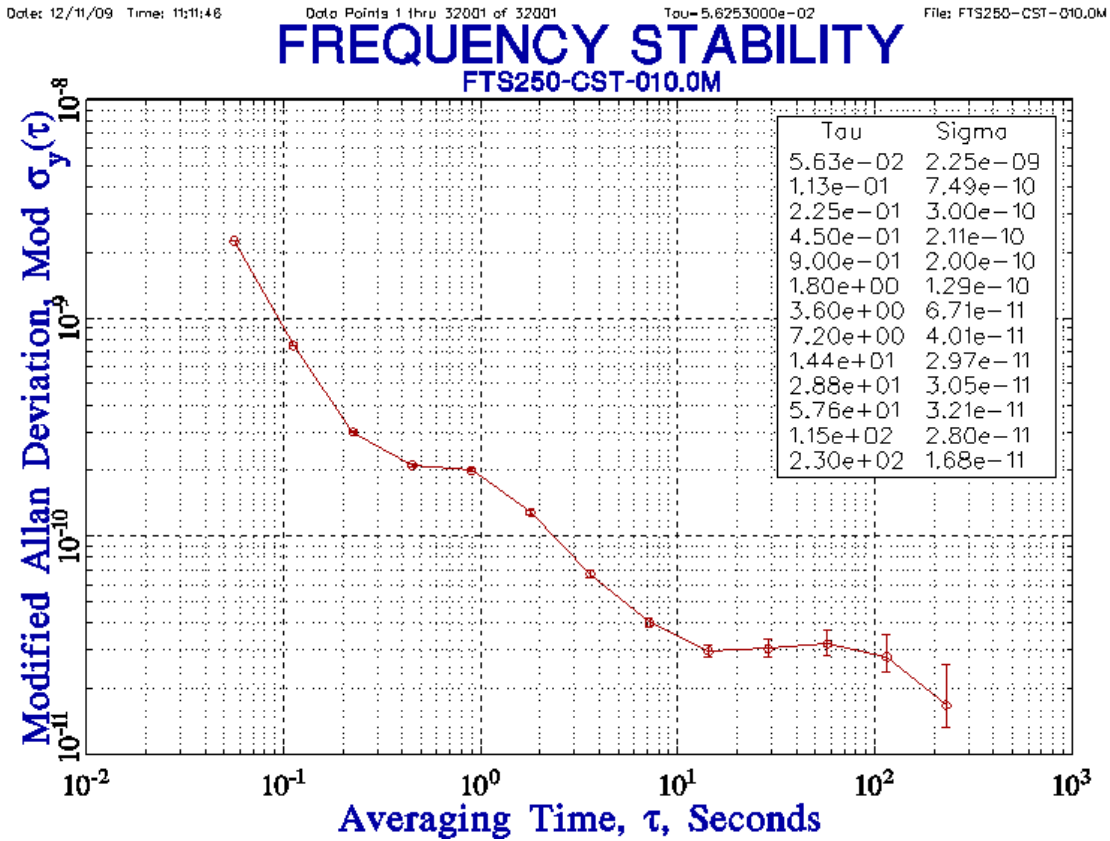

Wander Generation Plot – FTS250 versus G.811 Wander Generation Mask
Figure 4

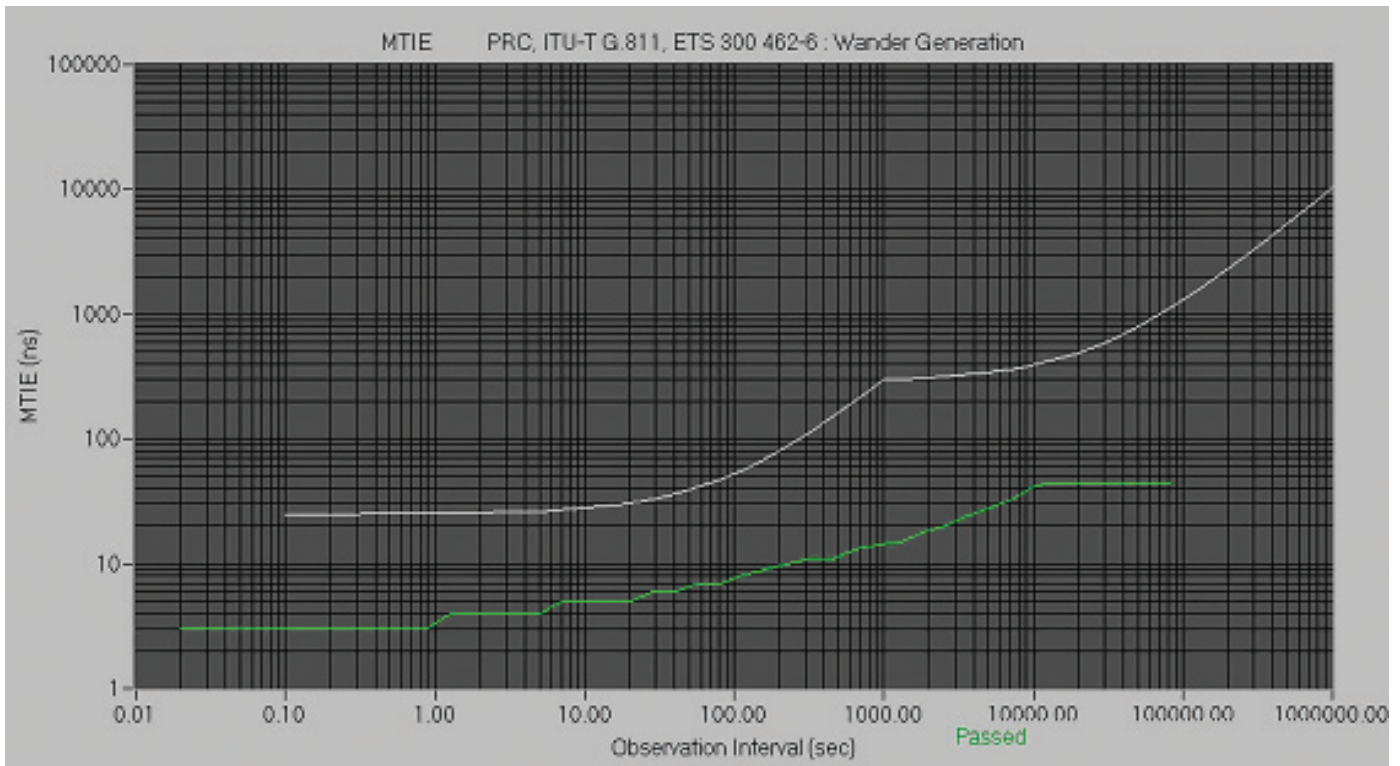

Soldering and Cleaning Recommendations

Hand solder, leaded wave solder, and lead-free wave solder processes are recommended for attaching the FTS250 after reflow processes are complete. Since the FTS250 does not have hermetic enclosure, hand cleaning the leads is recommended and the module should not be completely immersed.

Package Dimensions

Figure 5

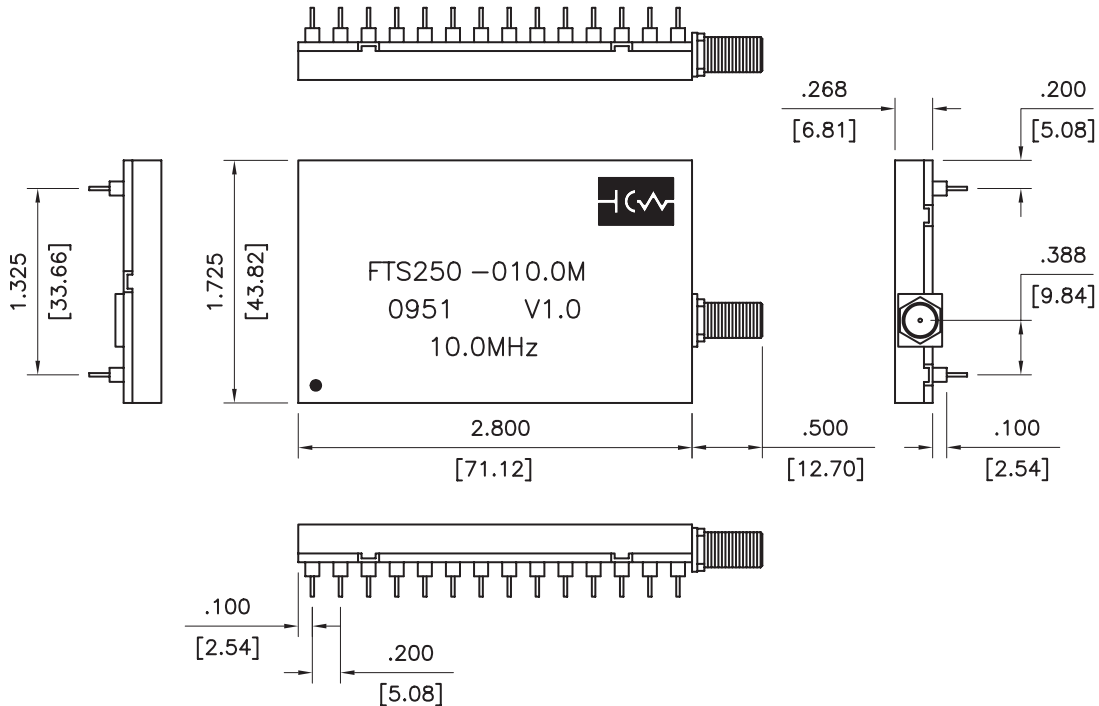

Top View Dimensions & Keep-out Area

Figure 6

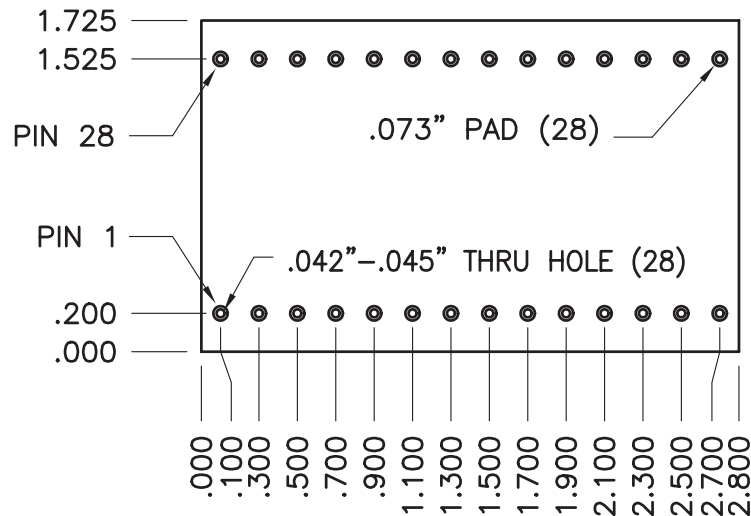



2111 Comprehensive Drive
Aurora, Illinois 60505
Phone: 630-851-4722
Fax: 630-851-5040
www.conwin.com

Ordering Information

FTS250	-010.0M
Output Frequency	

Revision	Date	Note
P00	01/19/10	Preliminary Release
00	06/14/10	125 Series Update and revised to release
01	05/27/11	Updated Block Diagram with Wi125 Receiver & Soldering Recommendations
02	01/03/12	Added Package & Physical Dimensions Information to Features